

Smart Lock User Manual



Special Attention:

1. Mechanical keys please keep outdoor, just in case keys lock in doors.
2. Please charge for the battery when low wattage alarm.
3. Reading this manual carefully before installation, and keep it for future reference.

1. Lock Structure

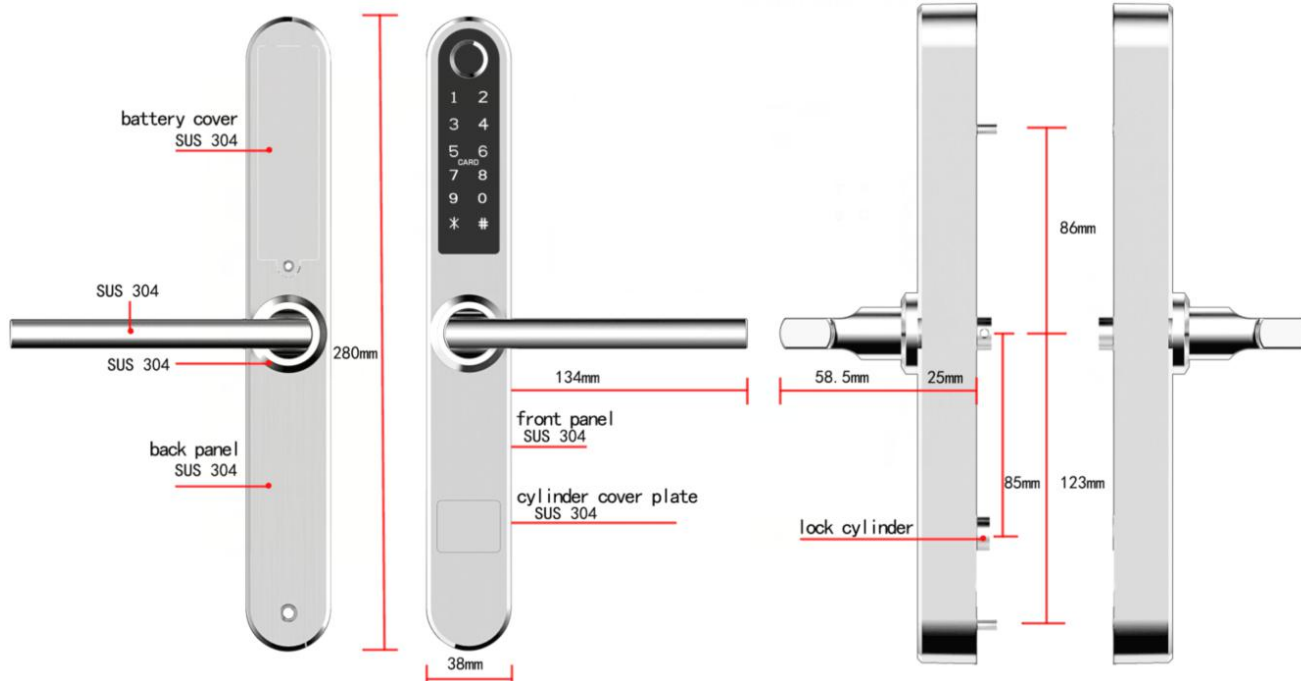

2. Mortise

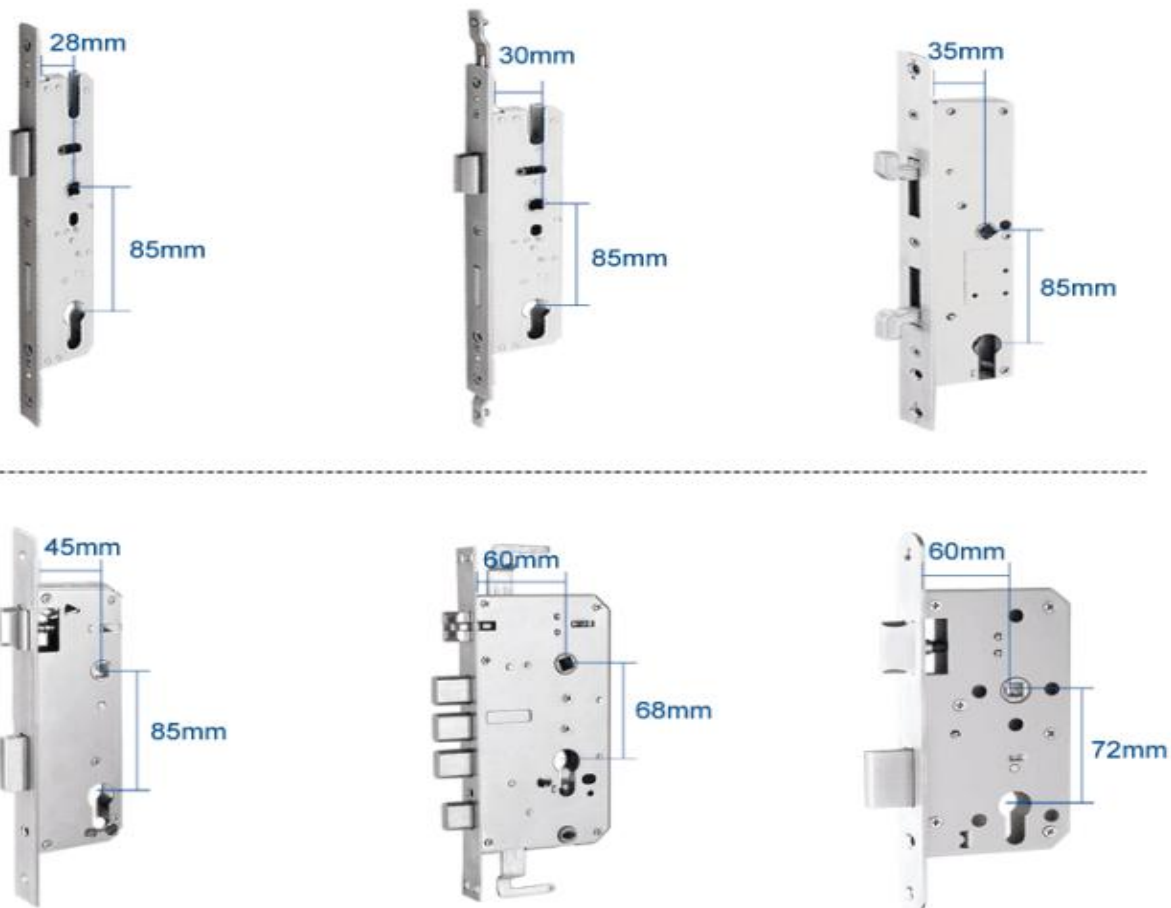

3. Installation

3.1 Installation Diagram

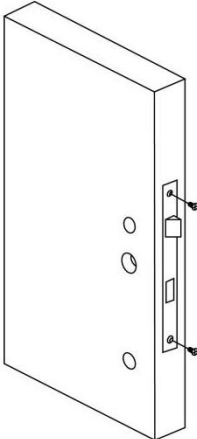
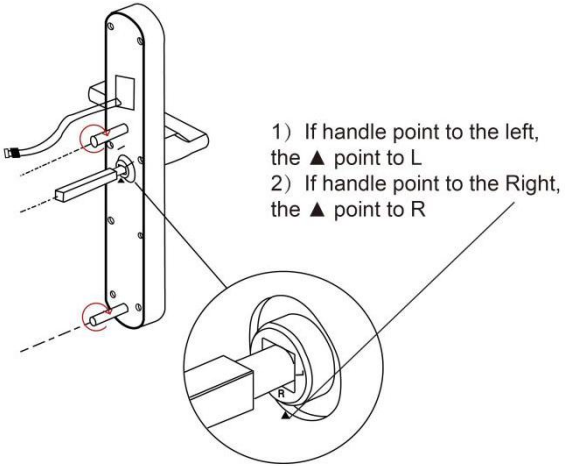
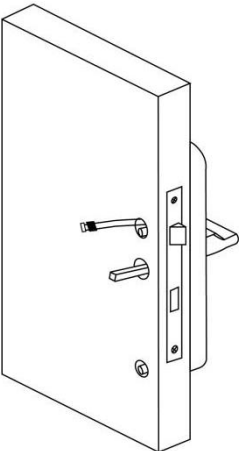
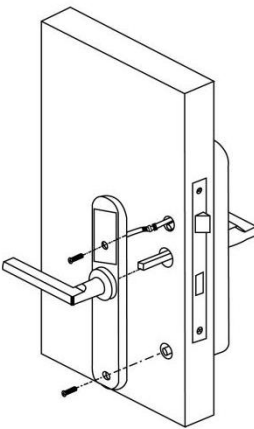
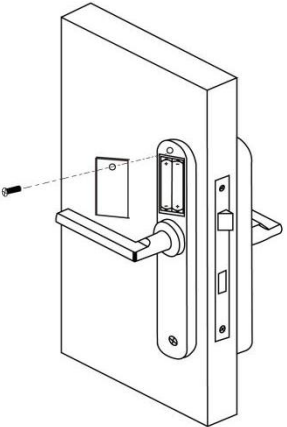
<p>Step 1 Install Mortise</p>	<p>Step 2 Install Square Shaft And Hexagon Screw Casing</p>
	 <p>1) If handle point to the left, the ▲ point to L 2) If handle point to the Right, the ▲ point to R</p>
<p>Step 3 Install Front Panel</p>	<p>Step 4 Install Back Panel</p>
	
<p>Step 5 Install the Battery</p>	
	

3.2 Turn the handle

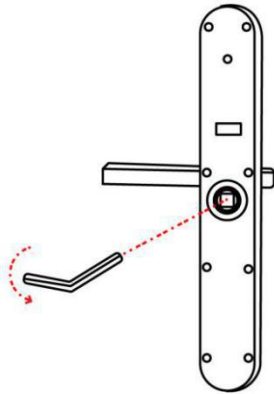

1、 Turn the handle on the front panel
Loosen the inner hexagon screw of the handle counterclockwise

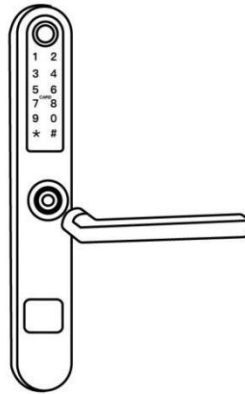

2、 Remove the handle

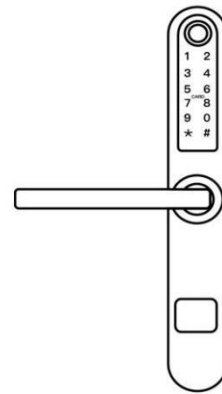

3、 After adjusting the direction of the handle, insert it into the handle seat and re-lock the hexagon screw of the handle to the complete the turning

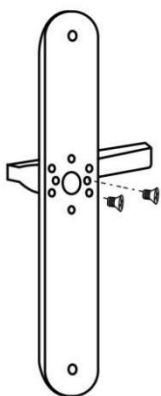

1、 Turn the handle on back panel
Remove the two screws with a cross screwdriver

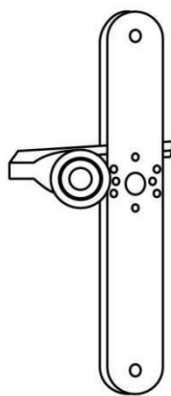

2、 Remove the handle

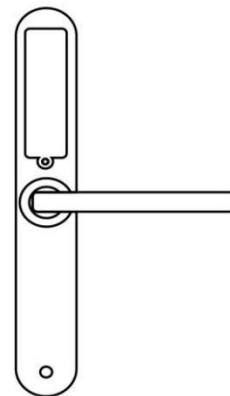

3、 After adjusting the direction of the handle, insert it into the handle seat and re-lock the two screws to complete the turning

4. Specifications

Suitable for Models	S31B
Materials	SS304
Front Panel Lock Size	280*38*25mm
Back Panel Lock Size	280*38*25mm
Lock Weight	2.5KG
Unlocking way	Bluetooth Fingerprint Password Card Mechanical key
Colour	Silver black Golden
Doors Applicable	aluminum door wooden door sliding door swing door
Working Voltage	6V/4x AAA batteries
Door Thickness to Fit	30-80mm
Data Capacity	Unlimited
Working Temperature	-20°C-70°C
Working Humidity	20%-90%
Low Wattage Alarm	Less than 4.5V

5. Registration



5.1 Connect lock to the phone

- 1) Android mobile phone, please scan the QR code as above
- 2) Apple mobile phone, please search “TTlock” from App Store.
- 3) Register a new account (phone number or email) or login with an existing account.
- 4) Touch the lock screen, click "+ Add Lock”
- 5) The lock nearby will appear on the phone screen, Click "+"
- 6) Re-name the lock
- 7) The lock added successfully

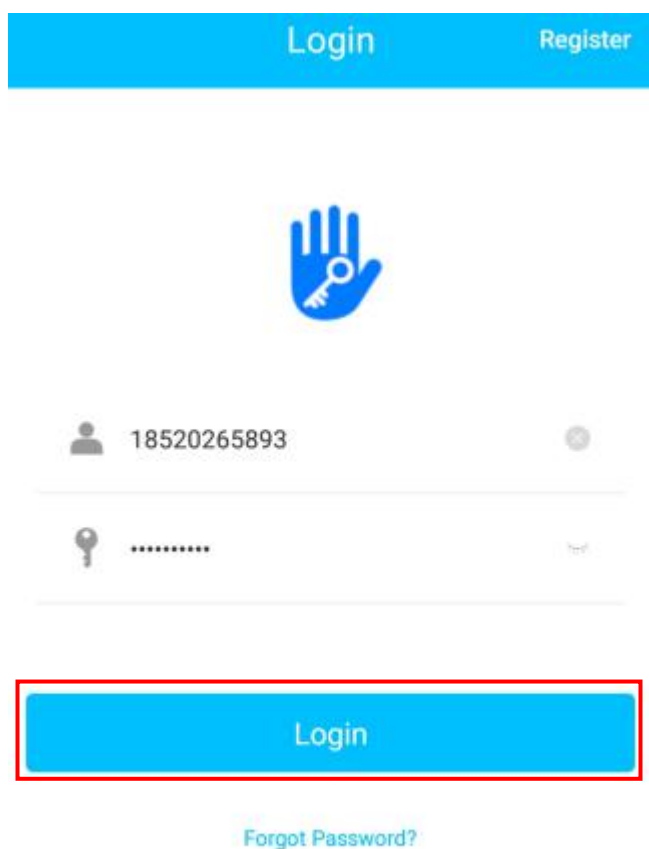



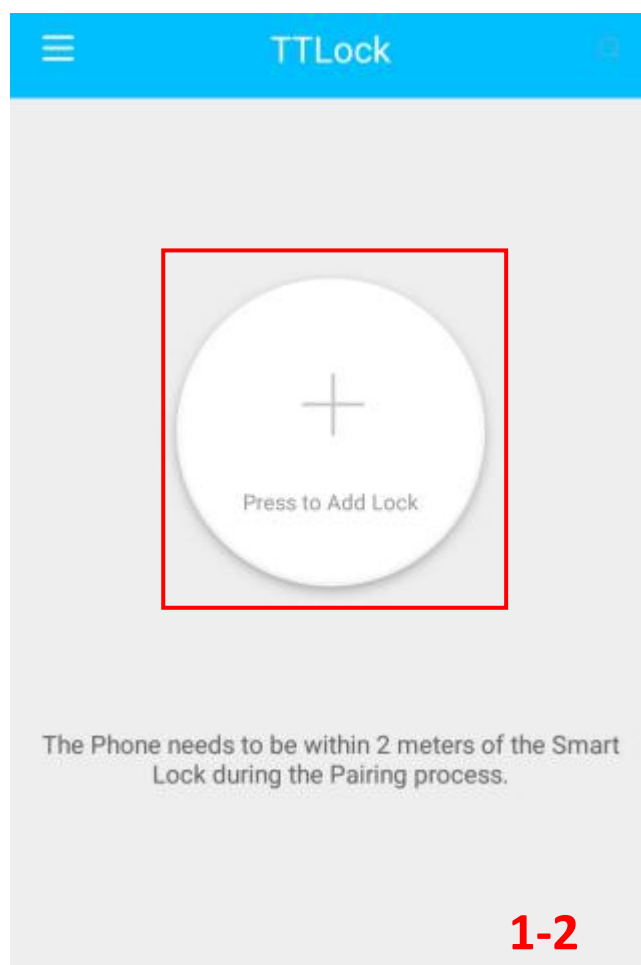

1-1





1-2

Choose Lock Type

-  Door Lock
-  Padlock
-  Safe Lock
-  Lock Cylinder
-  Parking Lock
-  Bicycle Lock

1-3

Nearby Locks

-  BL01_63230b
-  S202C_f4324e



1-4

Add Lock

Lock Name

S31B

1-5

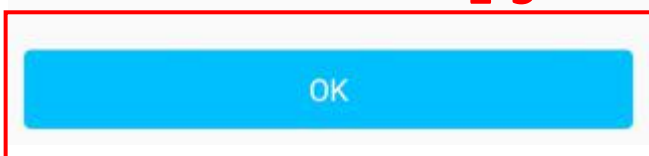

Added Successfully

Added Successfully



Lock Name S31B

Battery  100%

1-6

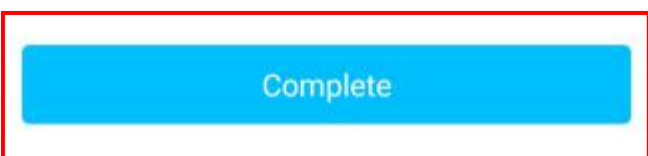

5.2 Unlock(The Admin unlock)

5.2.1 Bluetooth unlock

After mobile phone and door lock connected,Click " " as show as figure2- 1 to unlock.(the phone is within 5meters from the door lock)

5.2.2 remote control unlock(Option)

After confirming that your phone and door lock are connected to the gateway,Click " " as show as figure 2-1 to unlock.You can unlock it anywhere you have a network.(How to set up the gateway to connect to your phone refer to step 5.3)

5.2.3 Bluetooth key remote authorization

Click on the " " as shown in figure 2-1,you can send the eKey to other users of TTlock to authorize the unlock (the receiver must be download the APP and resiter an account) → Enter recipient's account of TTlock,set the name and effective time of the eKey as shown in figure 2-2 → Send → The recipient's account has bluetooth unlock permission

5.2.4 The Admin password unlock

Click " "as shown in figure 2-1→See Admin Passcode as shown in finger2-3→input Passcode on the keypad of lock →” #” to unlock.



5.2.5 Dynamic password unlock

Click " "as shown in finger 2-1→ finger 2-4 You can set the effective time and effective number of passwords→Generate password→Input password to unlock.



5.2.6 unlock records

Click " "as shown in finger 2-1→you can query your unlock record as shown in finger 2-5

5.2.7 Fingerprint unlock

Click "  " as shown in finger 2-1 → Click "  " → Add Fingerprint → set the name and effective time of the fingerprint → Start → Place your finger on the sensor follow the instructions → Add fingerprint OK → Place your fingerprint on the sensor to unlock.

5.2.8 Card unlock

Click "  " as shown in finger 2-1 → Click "  " → Add IC Cards as finger 2-6

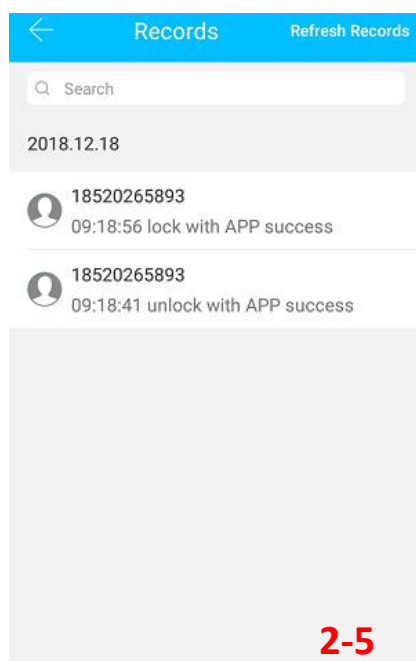
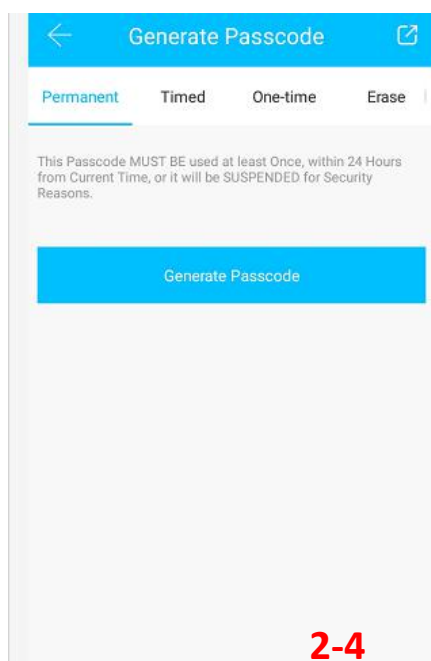
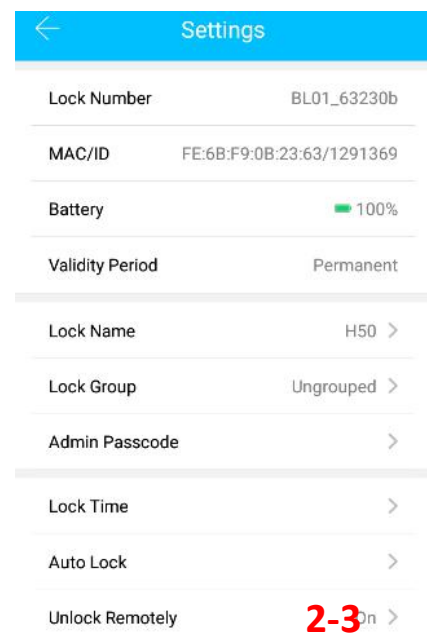
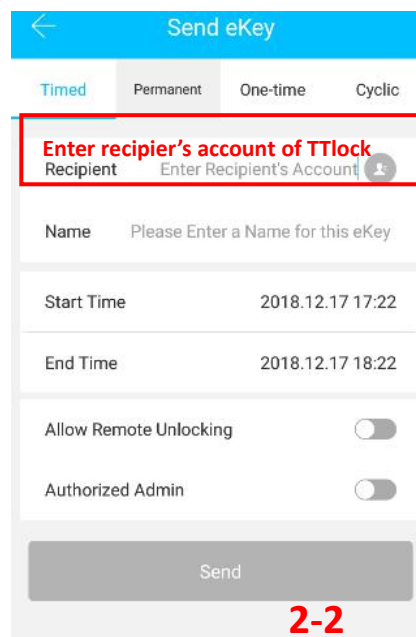
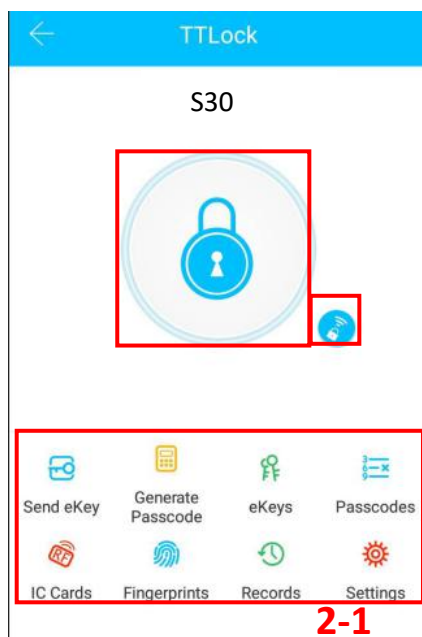





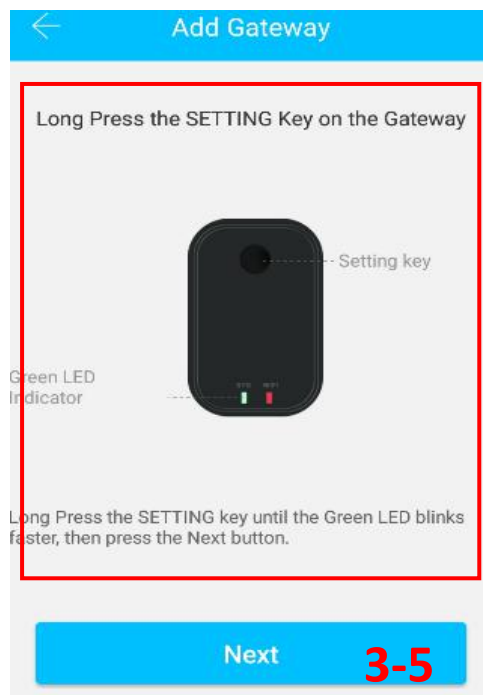
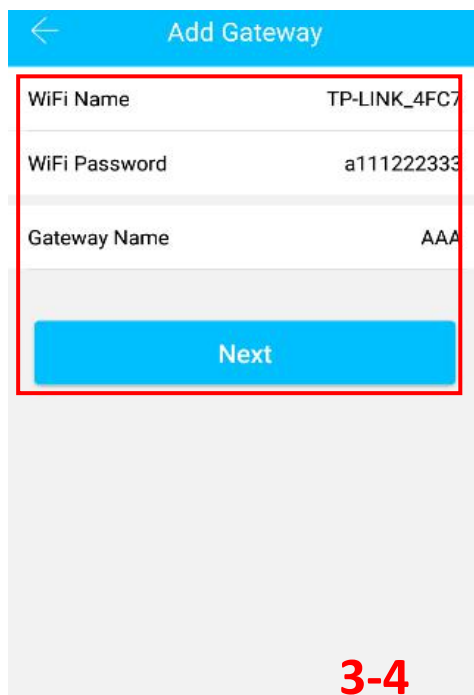
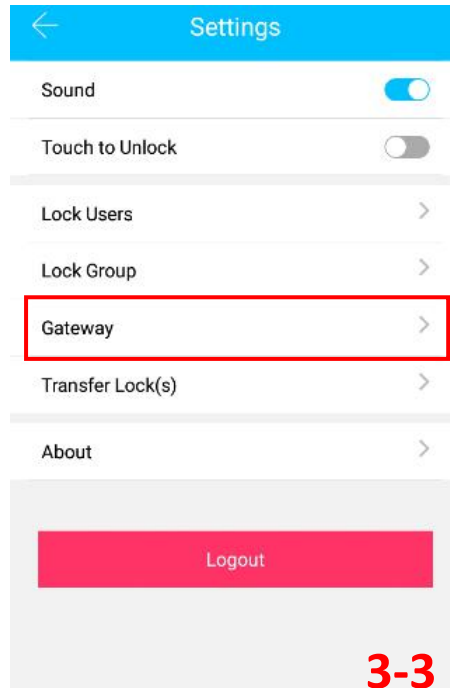
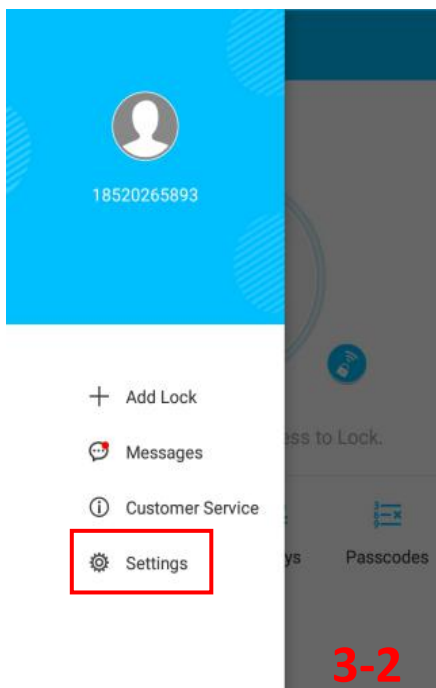
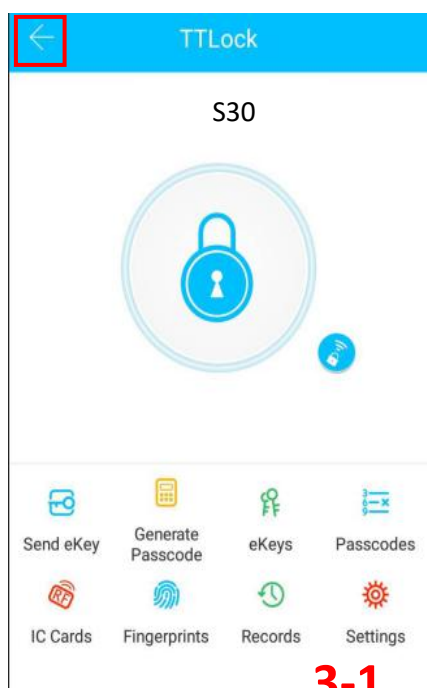





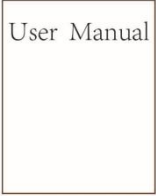

5.3 Set up the connection between the gateway and the phone(Optional)

Ensure your phone is connected to the desired WIFI network → Click " "as shown in finger 3-1 → Click "Settings" as shown in finger 3-2 → Click "Gateway" as shown in finger 3-3 → Enter WIFI password and Gateway name as shown in finger 3-4 → Longer press the SETTING key until the Green LED blinks faster, then press "Next" as shown in finger 3-5 → Setup complete

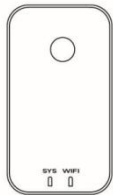

Packing List

Picture				
Name	Front Panel	Rear Panel	User Manual	Mortise
Quantity	1	1	1	1
Picture				
Name	Strike	Pointed screw	Mechanical Key	Card
Quantity	1	4	2	2
Picture				
Name	Square Shaft	Spring	Fixing screws	Hexagon screw casing
Quantity	1	1	2	2
Picture				
Name	Gateway			
Quantity	1(Optional)			

Guarantee

Customer name: _____

Customer calls : _____

Purchase date : _____

Product name : _____

Product model : _____

Note:

- 1) please keep this card so that you can use it when you need warranty service.
- 2) we provide you with a one-year warranty from the date of purchase.
- 3) this warranty service is valid for customers in any country in the world.