

OPERATION INSTRUCTION

TCP/IP Video Doorphone

Outdoor Unit
User Manual

Outlook and Connection

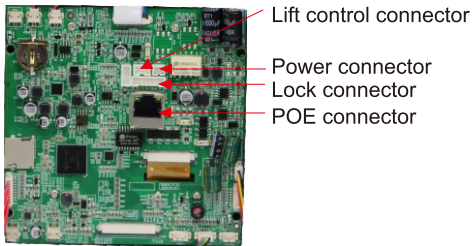
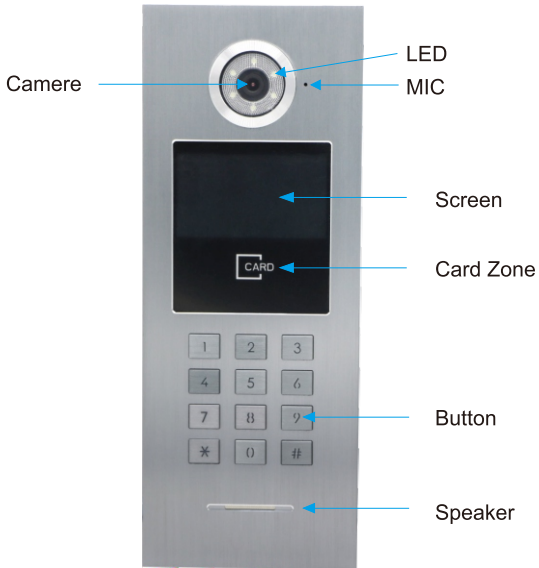

I .Parameter

CPU	Cortex-A7 1GHZ
LCD	7" (800*480)/4.3"(480*272)
Camera	1.0 Mega pixel, Digital WDR
Speaker	8Ω 1W speaker
MIC	High sensitivity MIC
Video Resolution	1280*720
Video Code	H.264 high profile supper low bitrate
Frame Rate	1-25fps adatable depends on network bandwidth
Audio Input/Output	Built=in Mic and speaker. support 2-way voice talk with echo cancellation
Peripheral	Mechanical key /Touch key
	Rj45
	Rs485
	Tamper alarm
	Human body sensor
	IC card
	Magnetic interface
Power Input	Exit button interface
	NO/NC/COM for Lock
	POE/12VDC
Size	300*204*26.5mm/365*140*50mm

Lift control connector

No.	Location	Definition	Function	Remark
J2	1	RS485B	485B date	
	2	RS485A	485A date	
	3	GND	GND	

Lock connector

No.	Location	Definition	Function	Remark
J3	1	NO_DC20V(brown)	Electric lock power supply	
	2	NC(orange)	NC	
	3	COM(green)	Common	
	4	NO(yellow)	NO	
	5	CTL(black)	Exit button	
	6	DEL(white)	Gate state detection	
	7	GND(red)	Ground	

Electronic lock wire diagram

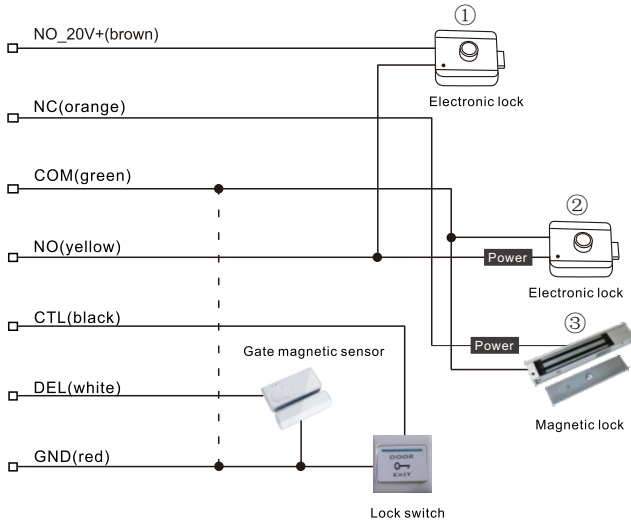

Note: When you choose the 2 or 3 type lock diagram connection, the dashed line don't need to connected.

II .Descriptions of Function

1. Intercom

- 1).Visitor input room number call indoor monitor and start intercom.
- 2).Visitor call control center from outdoor station.

2. Help function

The outdoor station can call the security room or the property center for consultation or help.

3. Access control unlock function

- 1).The outdoor station support password unlock.
- 2).IC card unlock.
- 3).The visitor call indoor monitor, monitor unlock.
- 4).Ask for control center unlock.

4. Video surveillance

- 1).The user monitoring outdoor situation and snapshot save in SD card.
- 2).Control center remote monitoring outdoor station camera.

5. Call lift function

The user call the lift with password and ID card.

6. Software remote upgrade automatic

The outdoor station automatically detects the latest software version information and performs new and upgrades in real time.

7. Tamper alarm function

When the device is removed, control center get alarm immediately .

8. Human sensing function

The display screen and button will light when the householder close the outdoor station.

III. Operation Instructions

1. The Main Interface

On standby, includes date&time display, network status, Visitors Calling, Password Unlocking, Call control center and User Instructions, as picture 3.1.1

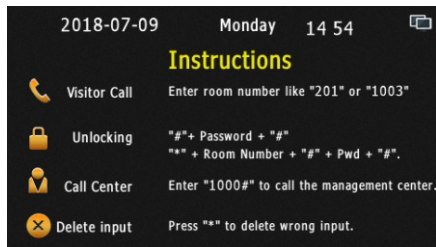

Picture 3.1.1

Note: all the operation instruction including text and icons Tips.

2. Video intercom

1).In main interface, visitors input the room no. , eg: input 101 or 0101, the three digits room no. call after 3 seconds, the four digits room no. call immediately, as picture 3.2.1

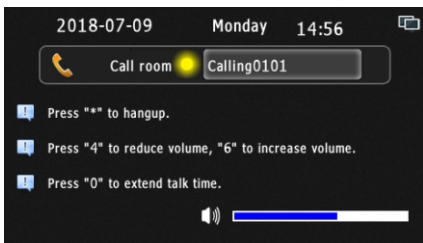

Picture 3.2.1

2).Entrance Station calls the indoor monitor, during main interface, the visitor needs to input the complete owner's room number information. For example, when calling the zone 1, 2 buildings, 1 unit, 401 room, you should enter "0102010401" to make the call, as picture 3.2.2

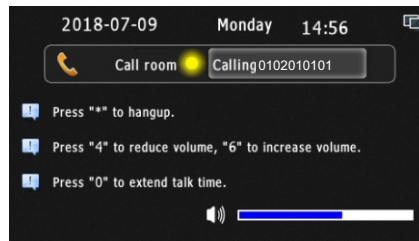

Picture 3.2.2

3).To input 1000 to call control Center, if the security machine does not exist or calling overtime, it transfer to the Management Center, as picture 3.2.3 and 3.2.4

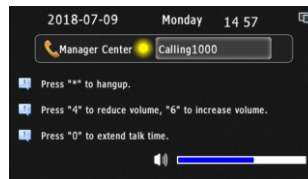

Picture 3.2.3

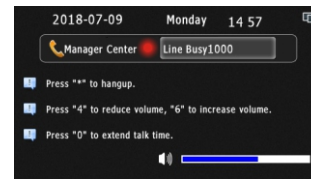

Picture 3.2.4

4).During input room number, press * delete mistake; During calling or talking, press * close call and talk. During the conversation, press "4" key low down volume, "6" key rise up volume, press "0" to extend the conversation time to be 60 seconds.

5). The indications of the Status Bar:

- Calling — Outdoor station calling indoor monitor/Control Center
- Busy — indoor monitor/Control Center busy
- Talking — intercom

6). Calling or intercom householder, monitor support unlock, the outdoor station will show “ the door is opened”, as picture 3.2.5



Picture 3.2.5

3. Unlocking function

1).Public password unlock. The factory default unlocking is Disable, it need the property staff to open permission by the project settings, program way: “#” + Public Password” + “#”, when the password is right, the gate lock will be opened, and snapshot photo to send to the Center, as picture 3.3.1

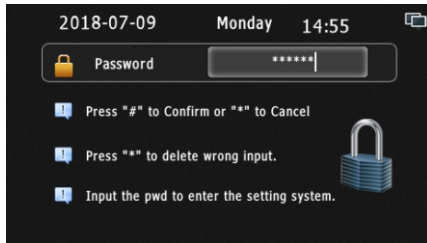

Picture 3.3.1

Input wrong password, notice mistake and snapshot picture send to center, as picture 3.3.2

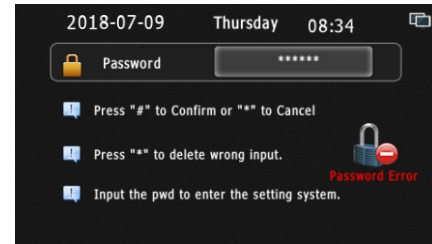

Picture 3.3.2

2) Hostage Password unlocking: Hostage Password opposite with Public Password, for example Public Password is 123456, Hostage Password is 654321. When using the Hostage Password to unlock, the outdoor unit will report to Hostage information to the Center, and inform SOS

3) User Password unlocking: factory default is Disable, it need the property staff to open permission by the program settings, User Password need to be set on the indoor monitor. Method: “*” + room no. + “#” + “User Password” + “#”, for example: User Password of Room 101 is 123456, to input “*+101+#+123456+#+” to open the unit gate, as picture 3.3.3

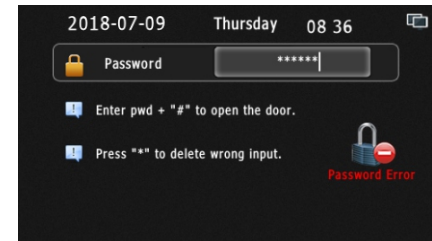

Picture 3.3.3

4)Hostage Password opposite with user's password. When finished use's password setting, hostage password auto create.

5)ID card unlock. as picture 3.3.4



Picture 3.3.4

IV. System Setting

1. Setting function instructions

Enter system setting mode: Please input “# + 6 digits administrator password + #” in the main interface (The factory default administrator password is 666666.), to press “*” to be back or delete the fault input, to press “#” to confirm it, “4” and “6” are for turn left or right, entering is the address setting, as followings picture 4.1.1 shows

This operation only can be operated by the professional engineering technicians. Users are not allowed to change the items.

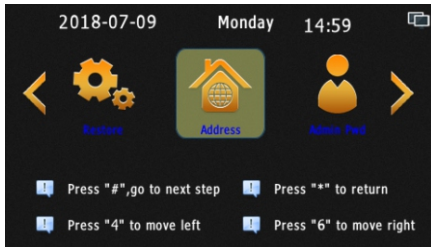

Picture 4.1.1

2. Address setting

- 1).Room no. composition rule: consist of 13 digits. The first one is the machine attributes (1 for unit outdoor unit, 7 for Entrance Station)
- 2).Room no. composition: attribute (1 digit) + district (2 digits) + building (2 digits) + unit(2 digits) + floor (2 digits) + room (2 digits) + extension(2 digits)

- 3).The factory default room no. is 2999999999901, to press “*” to delete the improper input, and press “#” to confirm ending.

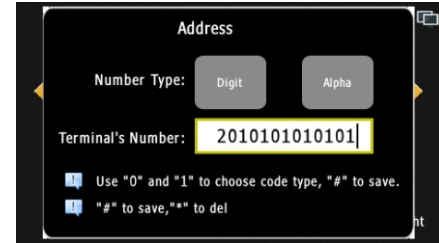

Picture 4.2.1

3. Administrator password setting

To revise the new administrator password: to input the right old password(6 digits) and new password(6 digits) twice, as the followings picture 4.3.1 shows

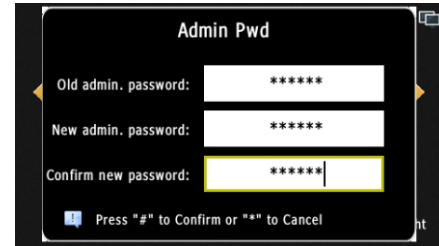

Picture 4.3.1

4. Unlocking Password setting

- 1).The Public Password and Hostage Password setting, input the right administrator password to set the new Public Password and Hostage Password. Noted: Two unlocking password are opposite, and they must be different. The factory default Public Password is 012345 and Hostage Password is 543210.If theThe Public Password is set to 666666 or 121121, The Public Password is the same as Hostage Password, and the setting rules are violated, indicating that the setting fails.

2).If set successfully, the interface and voice will indicate "Set successfully", if no, it set failed, the setting interface is followings4.4.1

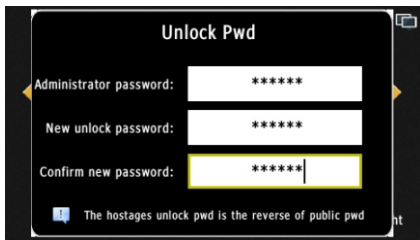

Picture 4.4.1

5. Password authorization

The factory default unlocking password is "Disable", following the interface indication, to press "0" to choose "Disable", the system could not be unlocked by password. To press "1" to choose "Enable" the Public Password, users could input the Public Password to open the gate; To press "2" to choose "Enable" the User Password, users could input the Public Password to open the gate. Pressing "*" to be "Back", "#" to confirm it, the setting interface as the followings picture 4.5.1 shows



Picture 4.5.1

6. Volume setting

The volume of advertisement or ring tone setting, to press "0" to set advertisement volume, to press "1" to set ring tone volume, to press "4" and "6" to adjust the volume up or down.

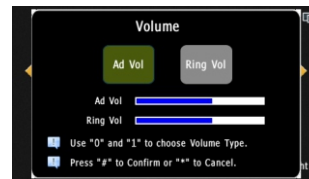

Picture 4.6.1

7. Unlocking setting

Unlock types and Lock Delay of electronic lock setting, the factory default is Power On Lock, and 10 seconds delay. Pressing "0" to choose Power Off Lock, pressing "1" to choose Power On Lock, pressing "#" to choose Lock Delay setting, to press "*" to confirm it after input the seconds time(Delay time limit is 1-150 seconds), pressing "*" to delete improper input or be back to the setting interface, as the followings picture 4.7.1 shows

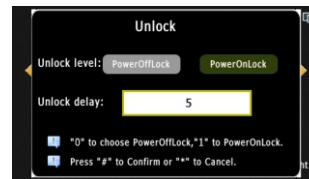

Picture 4.7.1

8. Sensor setting

"Enable" or "Disable" of Sensor setting, and "Open Sensor Delay". The factory default of Sensor is "Disable", delay time is 30 seconds, pressing "0" to choose "Disable", pressing "1" to choose "Enable", to press "*" to delete the delete time or be back to the setting interface, to "#" to confirm it and back, as the followings picture 4.8.1 shows

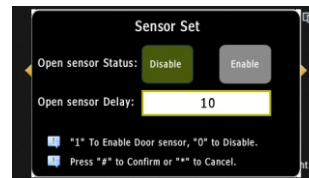

Picture 4.8.1

9. Language setting

Language setting, the factory default language is English, pressing "0" to choose Chinese, pressing "1" to choose "English", to press "#" to be back, to press "*" to confirm it and be back, as followings picture 4.9.1 and 4.9.2 show



Picture 4.9.1

10. Date setting

The Time and Date setting, if setting is unreasonable, it will indicate setting failed. When turning on or working, time will be same as the Property Center automatically. The format XXXX-XX-XX XX:XX, for example 2006-1-1 12:00, pressing "*" to delete the improper inputs, "#" to confirm to save it and be back, setting interface as followings picture 4.10.1 shows

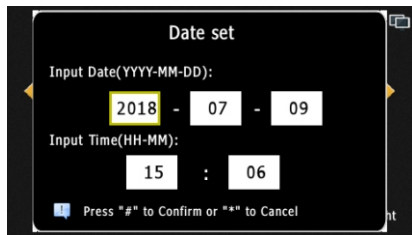

Picture 4.10.1

11. System information

You can check the local system information, included: Door no., Local IP address, Subnet mask, Gateway address, Software Version, Producer and NetCfg, as the followings picture 4.11.1 shows

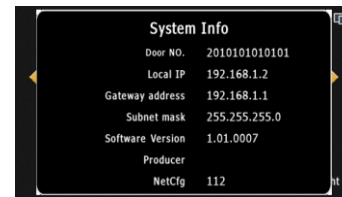

Picture 4.11.1

12. Card management

1).Adding User IC card, to press "0" to choose Add cards function, as followings picture 4.12.1 shows

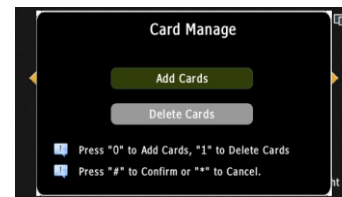

Picture 4.12.1

2).How to add IC card: to input the IC Card No. to add it, to input 4 digits for example 0101 on the Apartment Outdoor unit, to input 10 digits for example 0102010101(Room 101 Unit 1 Building 2 Area 1), on the Entrance Station, and to press "#" to confirm it, as the followings picture 4.12.2 shows

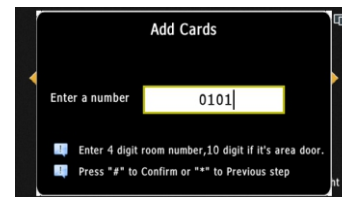

Picture 4.12.2

3).After input the right room No., to press “#” to confirm it, and begin to read the Card, as picture 4.12.3 indicates to put the Card on the Reader, please press “#” to end adding the Card, to press “*” to return.

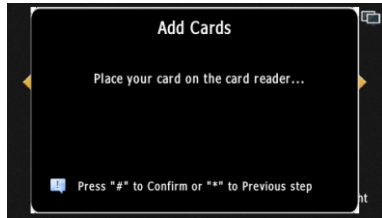

Picture 4.12.3

4).Pressing “1” to choose Delete the Card to the next step, as the picture 4.12.4, to press “0” to Delete the Card following the Card Number, to press “1” to Delete the Card following the Room Number, to press “2” to Delete all local cards.

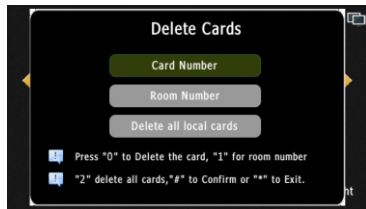

Picture 4.12.4

After pressing “0” + “#” to choose the Card Number, to input the IC Card number, if the IC Card exist on the Outdoor unit, it indicate Delete successfully, otherwise it indicate the Card number doesn't exist.

After pressing “1” + “#” to choose the Card Number, to input the IC Card number which need to be deleted, to input 4 digits Room Number on the Apartment outdoor unit, for example 0101 as the followings picture 4.12.6, to input 10 digits Room Number on the Entrance Station, for example 0102010101. If the Room Number exists the IC Card, please Delete all the household IC Cards; if no Cards, it indicates the Room Number input hasn't the IC Cards.

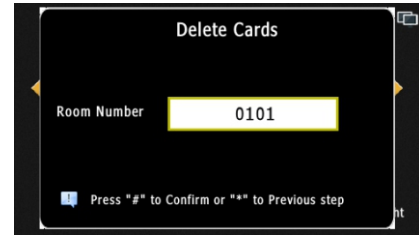

Picture 4.12.6

To input “2” + “#” to choose Delete all local cards, to press “#” to confirm it, to press “*” to Return it, as the followings picture 4.12.8 shows



Picture 4.12.8

13. Restore default settings

To click the button "Restore", please press "#" to restore factory setting and "*" to cancel whether need reset, as the followings picture 4.13.1 shows



Picture 4.13.1

VI. Installation process of outdoor units

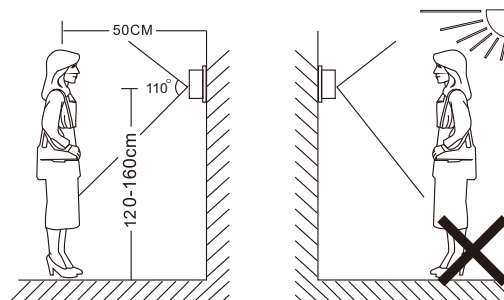

V. Operation Instructions

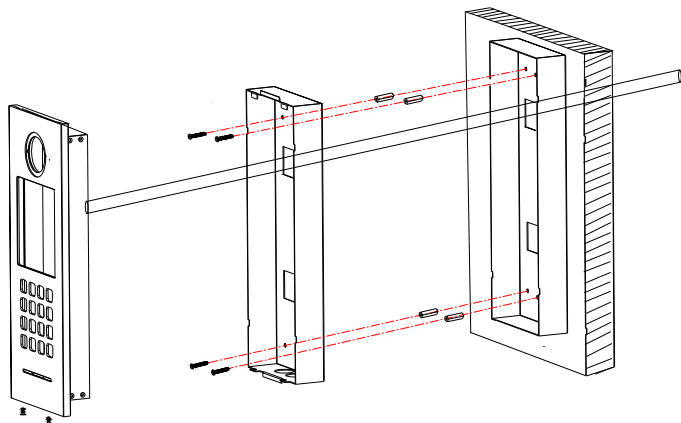

NOTE:

- Avoid installation of the device near strong radiation e.g. AC motor and lift .
- Maintenance should be complied with qualified technician .
- Avoid hard shake , beating and collision ,otherwise the internal exact components maybe be damaged .
- Do not expose the outdoor camera under strong light or sunshine.
- Do not install the outdoor camera in the environment e.g. direct sunlight ,contact rain ,High temperature ,high humidity ,full of dust and chemistry corrosive.
- Select the most suitable position where the camera is located at user's eye level
- Switch off power supply before installation.
- Keep more than 30cm away from AC power supply to avoid external interference.
- Keep it away from the water and magnetic field.